

INSTRUCTIONS



A0602/A0604 On-Wall Dock Station

 CHANNEL VISION™

©2012 CHANNEL VISION TECHNOLOGY

Introduction

Thank you for purchasing Channel Vision's A0602 on wall dock. Please take the time to read over these instructions to ensure years of enjoyment.

Features

Transform your Apple iPad into a wireless on-wall touch screen panel. The iPad securely mounts to the wall creating a touch screen controller ideal for home theater, whole-house automation, security and AV applications. Be able to mount your iPad horizontally or vertically and easily remove your iPad when you need it for portable use.

Key features:

- Control your home automation system
- Charges your iPad while it's docked
- Display your favorite photo when iPad is removed
- Securely mounts vertically or horizontally to any wall
- Easily view your cameras with the Channel Vision camera app

Safety Warnings

IMPORTANT SAFETY INSTRUCTIONS

1. Read these instructions in their entirety.
2. Keep these instructions for future reference and warranty details.
3. Heed all warnings.
4. Follow all instructions.
5. Clean only with a dry cloth.
6. Install in accordance with these instructions.
7. Do not install near any heat sources such as radiators, heat registers, stoves, or other apparatus that produce heat.
8. Only use attachments/accessories specified by Channel Vision.
9. Unplug this apparatus during lightning storms or when unused for long periods of time.
10. Refer all servicing to a qualified Channel Vision professional installer.
Servicing is required when the dock has been damaged in any way.
11. Inside of apparatus shall not be exposed to dripping or splashing and objects filled with liquids.

Box Contents

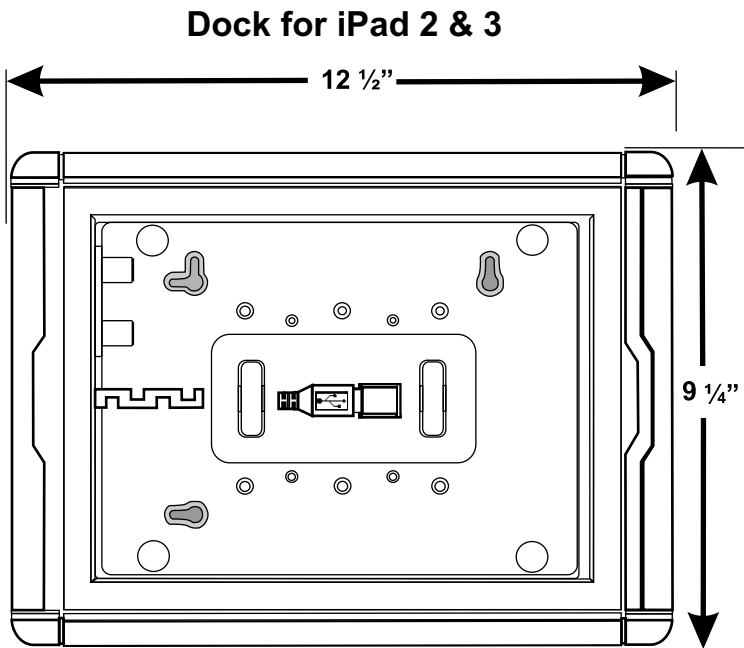

Items Included:

- (1) Dock
- (1) Power plate
- (1) 15vDC 800mA power supply
- (6) Mounting screws
- (1) Picture backing
- (4) Glue Sticking for picture

Tools & Accessories

Required (Not included):

- (1) USB to iPad® charging cable
- (1) Punch down tool
- (1) Wire stripper
- (1) Small flathead screwdriver
- (1) iPad® 2nd or 3rd generation
- (1) 3 Gang backbox (see page 4)
- (1) 1 Gang backbox
- (1) CAT5 wire or 18/2 wire

Power Supply

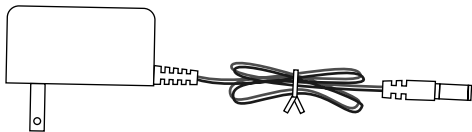

Power Plate

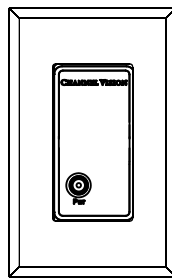

Picture Backing

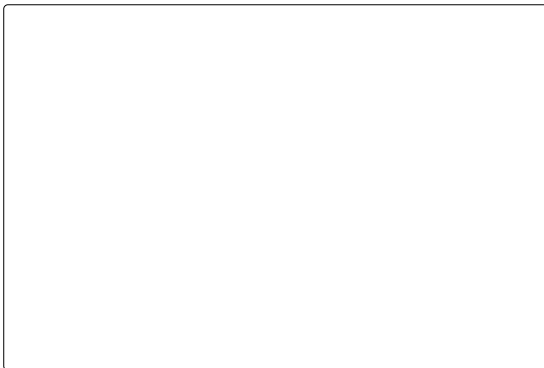

Installation

Note:

Example below illustrates using CAT5 cable.
18/2 wire can be used instead of CAT5 type cable.

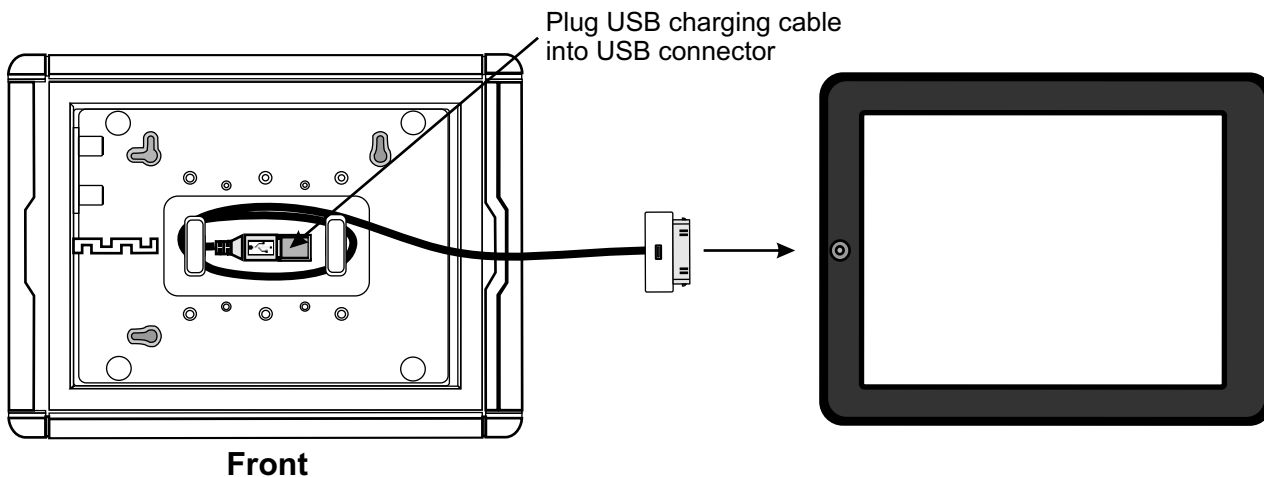
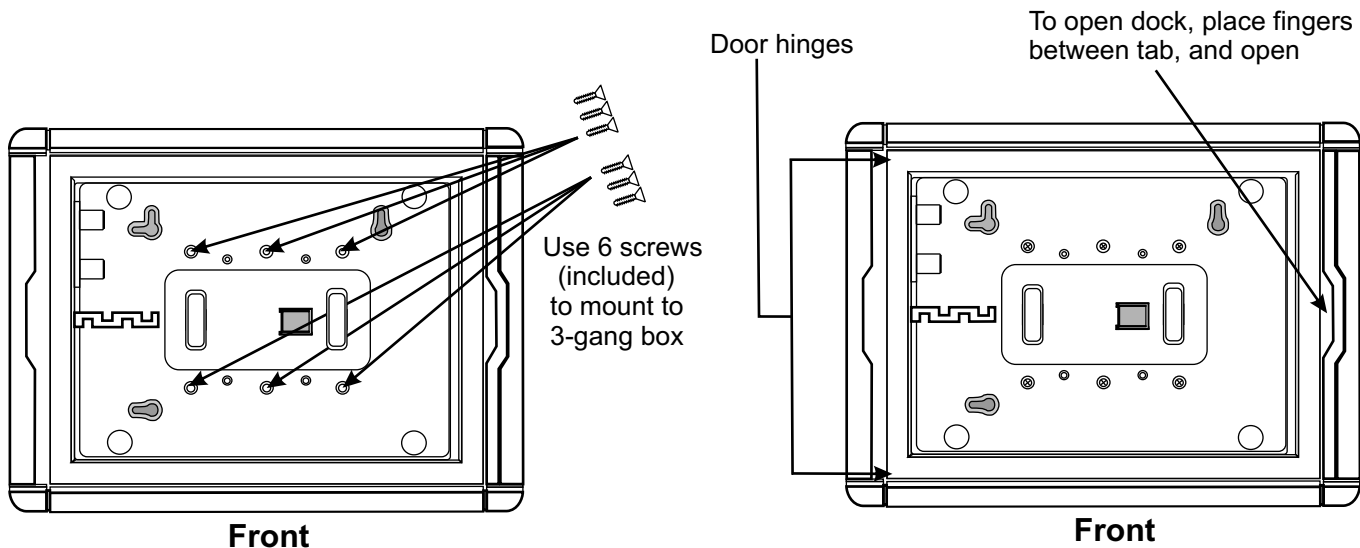
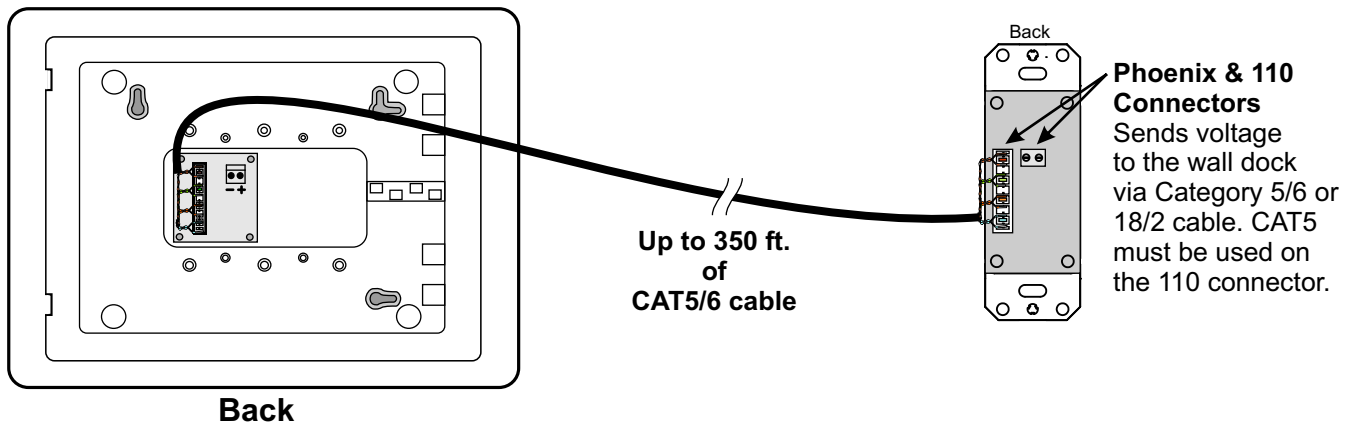

Related Products

The Channel Vision iPad app is an application designed for viewing Channel Vision IP cameras, such as the 6564, 6543, and 6544. This application is available from the App store.

Features:

- Live viewing of a single or split screen
- Portrait and landscape viewing
- Multi-camera management for vacation homes or multi-location businesses
- Instantly capture a snapshot to add to your Photo Library
- Control of pan – tilt – zoom functions

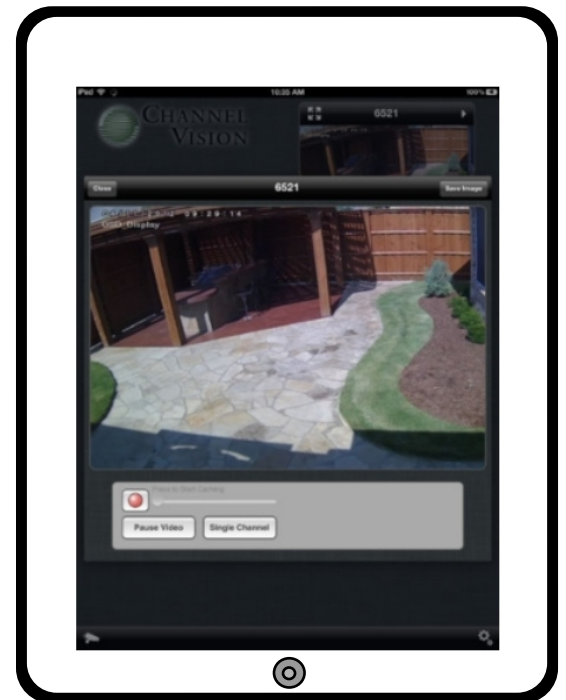
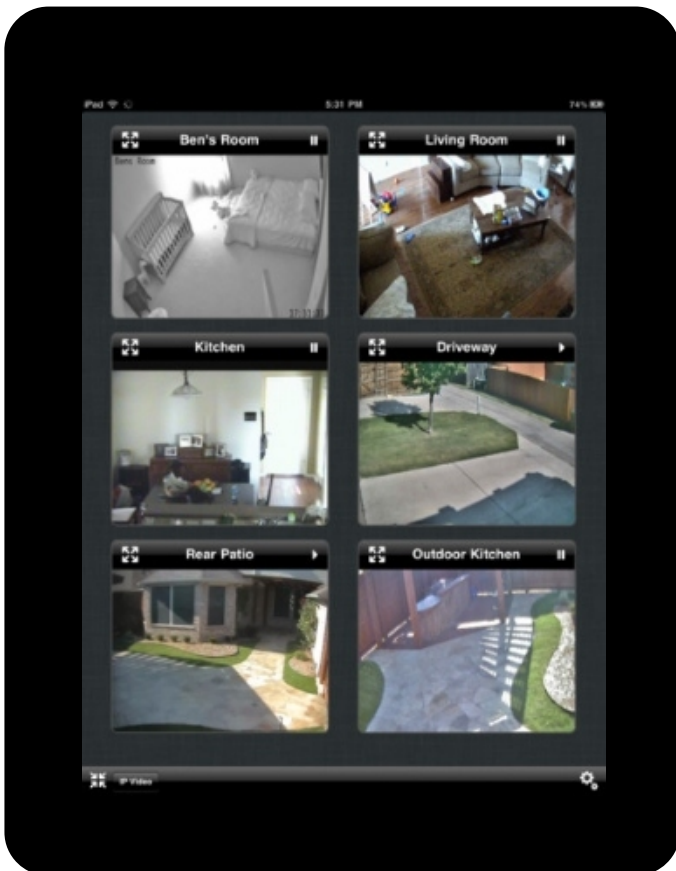

Related Products



- 2MP for superior HD image quality
- H.264 compression takes less space
- 18 IR LED's for a viewing up to 45ft.



- 2MP for superior HD image quality
- H.264 compression takes less space
- 35 IR LED's for a viewing up to 60ft.



- 1.3 megapixel CMOS sensor
- 2 gang box included
- Event triggered Micro SD card recording



- 1.3 megapixel CMOS sensor
- Built-in IR LED for up to 15ft.
- Event triggered Micro SD card recording

Troubleshooting

Problem	Possible Cause	Solution
Not charging	Power supply is disconnected or damaged	Check power supply (15vDC at dock)
	Power supply voltage is too low	Verify distance of 350' or less. Confirm 15vDC on each CAT5 pair (blue, green, orange, and brown)
	Faulty cable connections Battery drained, turn off iPad and plug into dock, let charge for 30 minutes before turning iPad on	Check with cable tester or verify cable (18/2 or CAT5/6) Match color code of wires on both sides of cable. Set up both items on a bench with a test cable to check functionality.
	Faulty cable connections	If using CAT5, twist all solid wires together, and all striped together, and place in screw terminal instead. Test for 15 Volts DC at the cable going into dock.
	iPad is running too many applications	Press the Home button twice. It will slide your screen up and display a row of running apps. Press and hold the application icon (the same way you hold to organize and delete apps on your home screen). A red minus (-) symbol will display on the top left corner of the app icon. Pressing this red (-) will exit each process.

Specifications

Operating Voltage: 15vDC 800mA

CAT5/6 Distance : 350' 8 conductor

18/2 Distance: 350' 2 conductor

Dock box required: 3 gang box; 0TW2-34; Southwire Romex box recommended, not compatible with Arlington brand boxes

Breakout box required: 1 gang (standard)

Charging Voltage: 5.10vDC +/- 0.3V at USB cable



1 Year Limited Warranty

Channel Vision Technology will repair or replace any defect in material or workmanship which occurs during normal use of this product with new or rebuilt parts, free of charge in the USA, for one year from the date of original purchase. This is a no hassle warranty with no mail in warranty card needed. This warranty does not cover damages in shipment, failures caused by other products not supplied by Channel Vision Technology, or failures due to accident, misuse, abuse, or alteration of the equipment. This warranty is extended only to the original purchaser when purchased through an authorized reseller. A purchase receipt, invoice, or other proof of original purchase date will be required before warranty repairs are provided.

Mail in service can be obtained during the warranty period by calling (714) 424-6500. A Return Authorization number must be obtained in advance and can be marked on the outside of the shipping carton.

This warranty gives you specific legal rights and you may have other rights (which vary from state to state). If a problem with this product develops during or after the warranty period, please contact Channel Vision Technology, your dealer or any factory-authorized service center.

Channel Vision products are not intended for use in medical, lifesaving, life sustaining or critical environment applications. Channel Vision customers using or selling Channel Vision products for use in such applications do so at their own risk and agree to fully indemnify Channel Vision for any damages resulting from such improper use or sale.

FC Tested To Comply
With FCC Standards



This device complies with part 15 of the FCC rules. Operation is subject to the following two conditions: (1) This device may not cause harmful interference, and (2) This device must accept any interference received, including interference that may cause undesired operation.

Apple is not responsible for the operation of this device or its compliance with safety and regulatory standards. iPad is a trademark of Apple Inc., registered in the U.S. and other countries.

 **CHANNEL VISION™**
www.channelvision.com

234 Fischer Avenue, Costa Mesa, California 92626 USA
(714)424-6500 • (800)840-0288 • (714)424-6510 fax
email: techsupport@channelvision.com